

SERVICE MANUAL



FISHER

DIGITAL COMPACT DISC PLAYER

DAC-204

(EUROPE)

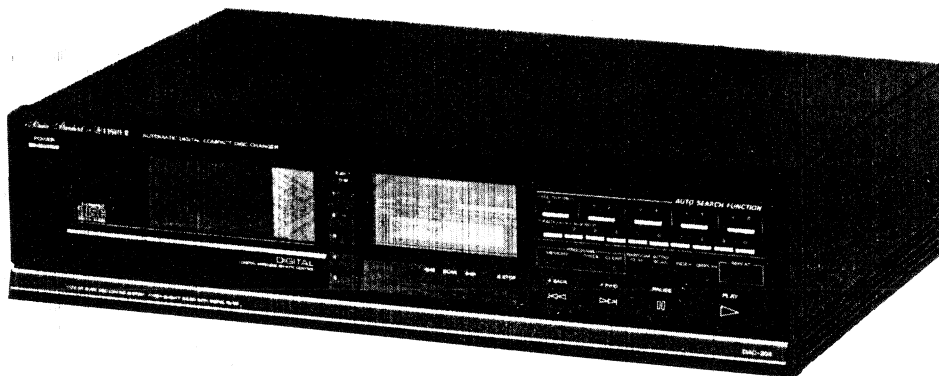

137 326 42

SPECIFICATIONS

System Compact disc digital audio system

AUDIO CHARACTERISTICS

Frequency Response 20 Hz – 20 kHz
Harmonic Distortion Less than 0.006 % (1 kHz)
S/N Ratio More than 90 dB
Wow and Flutter Below measurable limits
Channel Separation More than 80 dB (1 kHz)

FUNCTIONS

Disc Selection With DISC NUMBER
(1 ~ 5) buttons
Track Selection With TRACK/INDEX
NUMBER (0 ~ 9) buttons
Index Selection With INDEX and TRACK/INDEX
NUMBER (0 ~ 9) buttons
(normal disc play only)
Program Selection With DISC NUMBER (1 ~ 5),
TRACK/INDEX NUMBER (0 ~ 9)

Program Functions 32 selections
Program Reset Press CLEAR button
Checking Program With CHECK button
(in STOP mode)
Intro Scan 1 ~ 99 sec. programmable
Scanning 2 speed fast-forward/back with sound,
2 speed search in PAUSE mode
Random Disc Play Press RANDOM PLAY button
Total Disc Time Display Press DISPLAY button twice
Repeat All tracks, all programmed tracks

GENERAL

Power Requirements (50 Hz) AC 110/220V
20 Watts
Dimensions (W x H x D) 440 x 113 x 290 mm
Weight (approx.) 5.0 kg

CABINET EXPLODED VIEW

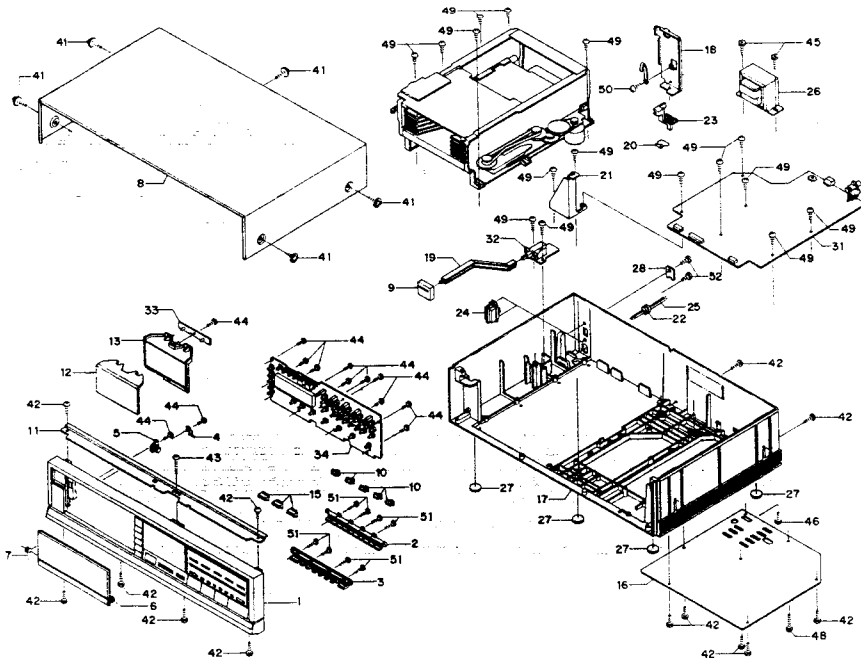

CABINET PARTS LIST

Ref. No.	Part No.	Description	Q'ty	Ref. No.	Part No.	Description	Q'ty
PACKAGE					4-2352-02866	Connector 1P Assy	1
131-2-7103-54600	Label (50th)	2		4-2352-02867	Connector 1P Assy	1	
131-6-1169-20909	Box Corrugate-Exp	1		131-2-1310-40571	Name Plate (Rating)	1	
131-6-3009-36570	Pad (Left)	1		131-6-4159-39600	Notes (Laser)	1	
131-6-3009-36580	Pad (Right)	1		131-6-4159-40200	Notes (Laser)	1	
131-6-3069-16350	Patching Sheet	1		131-6-4159-40300	Notes (Laser)	1	
141-6-2519-22290	Sheet Polyethylene	1		141-2-4459-44000	Cushion (Escutcheon Dial)	1	
141-6-4559-03300	Serial No. Sheet	2		141-2-4459-44100	Cushion (Escutcheon Dial)	1	
ACCESSORIES					141-2-4729-04200	Lug	1
4-2359-79410	Connector 5P Assy	1	1	141-6-4559-03300	Serial No. Sheet	1	
4-2369-74132	Plug Cord RCA 1.0 BK	1	2	131-0-1015-12206	Escutcheon Dial Assy	1	
131-6-2719-10401	Bag Fan	1	3	131-0-1001-64400	Knob Track No. Assy	1	
141-6-4159-00645	Notes	1	4	131-0-1001-64500	Knob Function Assy	1	
142-6-4119-33475	Explanatory Booklet	1	5	131-2-4119-10800	Metal Mount Shaft	1	
			6	141-0-5519-08507	Gear Eject Assy	1	
			7	141-0-1249-46902	Lid Disc Assy	1	
			8	141-2-8529-40300	Spring Door	1	
			9	131-2-1410-32800	Cover	1	
CABINET & CHASSIS					131-2-1601-90903	Knob Power	1
4-2352-02179	Connector 6P Assy [CN6]	1	10	131-2-1601-97800	Knob Push (L)	5	
4-2352-02474	Connector 2P Assy [CN7]	1	11	131-2-3201-12800	Angle Reinf	1	
4-2352-02348	Connector 4P Assy [CN8]	1	12	131-2-3602-12701	Filter (Index)	1	
4-2352-02333	Connector 5P Assy [CN9]	1	13	141-0-1149-17800	Mount Screen Assy	1	
4-2352-02178	Connector 6P Assy [CN10]	1	15	141-2-1659-83200	Knob Scan	3	
4-2352-02722	Connector 1P Assy	1	16	131-2-1105-32400	Plate Bottom	1	
4-2352-02655	Connector 1P Assy	1	17	131-2-3301-33006	Chassis Main	1	
4-2352-02664	Connector 1P Assy	1	18	131-2-3311-10900	Metal Mount Cover	1	

CABINET PARTS LIST (Continued)

Ref. No.	Part No.	Description	Q'ty	Ref. No.	Part No.	Description	Q'ty
19	131-2-4219-20400	Shaft	1	41	141-2-4219-33101	Screw, Bind Hd, Tapping-B, +M3.0x8	5
20	134-2-5103-11700	Spring Plate	1	42	411 099 9803	SCR S-TPG BRZ 3X8	14
21	141-2-3519-84400	Bracket Chassis	1	43	411 064 3607	SCR TPG BIN 3X16	1
22	141-2-3899-10400	Heyco Bushing	1	44	411 020 5508	SCR S-TPG BRZ 2.6X6	13
23	141-2-7429-06500	Lever Lock	1	45	411 006 2804	SCR TPG BIN 4X10	2
24	△ 4-2312-02650	Switch Slide 3P (AC SELECTOR) [SW602]	1	46	411 020 6406	SCR S-TPG BRZ 3X12	1
25	△ 4-2432-00500	Power Cord	1	48	143-3-1903-02518	Screw, Brazier Hd, Tapping-B, +M3.0x25	1
26	△ 4-2512-34620	Power Trans	1	49	411 020 8004	SCR S-TPG BRZ 3X8	14
27	131-2-1801-16200	Leg	4	50	411 020 7700	SCR S-TPG BRZ 3X6	1
28	131-2-7104-00500	Plate Pad Switch	1	51	411 021 0809	SCR S-TPG BIN 2X6	8
				52	411 002 9104	SCR PAN 3X8	2
31	141-0-1939-20515	Main P.C.B. Assy	1	NOTES:			
32	141-0-1939-20542	Power P.C.B. Assy	1	1. Parts order must contain Model Number, Part Number and Description.			
33	141-0-1939-20550	Lamp P.C.B. Assy	1	2. Ordering quantity of screws and resistors must be multiple of 10 pcs.			
34	141-0-1939-20522	Control P.C.B. Assy	1				

PRODUCT SAFETY NOTICE

Each precaution in this manual should be followed during servicing. Components identified with the IEC symbol Δ in the parts list and the schematic diagram designate components in which safety can be of special significance. When replacing a component identified with Δ , use only the replacement parts designated, or parts with the same ratings of resistance, wattage or voltage that are designated in the parts list in this manual. Leakage-current or resistance measurements must be made to determine that exposed parts are acceptably insulated from the supply circuit before returning the product to the customer.

SAFETY INTERLOCK

The Digital Compact Disc Player reads the disc signal by detecting the laser beam. It must be avoided for the human body to directly receive the beam. Especially human eyes are badly affected by the beam. Therefore, the unit is equipped with an interlock to prevent the unnecessary laser outputs.

following two conditions are met, the laser emits the beam.

- 1) When the Loading Limit Switch is set in "ON". (The disc is set to the turntable.)
- 2) The pickup is located at the area of the minimum internal circumference.

The laser outputs are controlled by the injection or cutoff of the constant voltage source to the laser diode with Pin 16 of IC 901 (μ PD75206G). When Pin 16 is in "L" (Low) level, the laser emits the beam. When Pin 16 is in "H" (High) level, the laser does not emit the beam.

After the above conditions are met and the index signals have been read, the laser emits the beam when the following two conditions are met.

Pin 16 is set in "H" level when the unit is loaded with the disc and it reads the index signals or when the unit is set in the play mode after that. When the unit reads the index signals and the

1. When the PLAY button is pressed.
2. When the PLAY indicator is ON.

CD INDEX MECHANISM EXPLODED VIEW

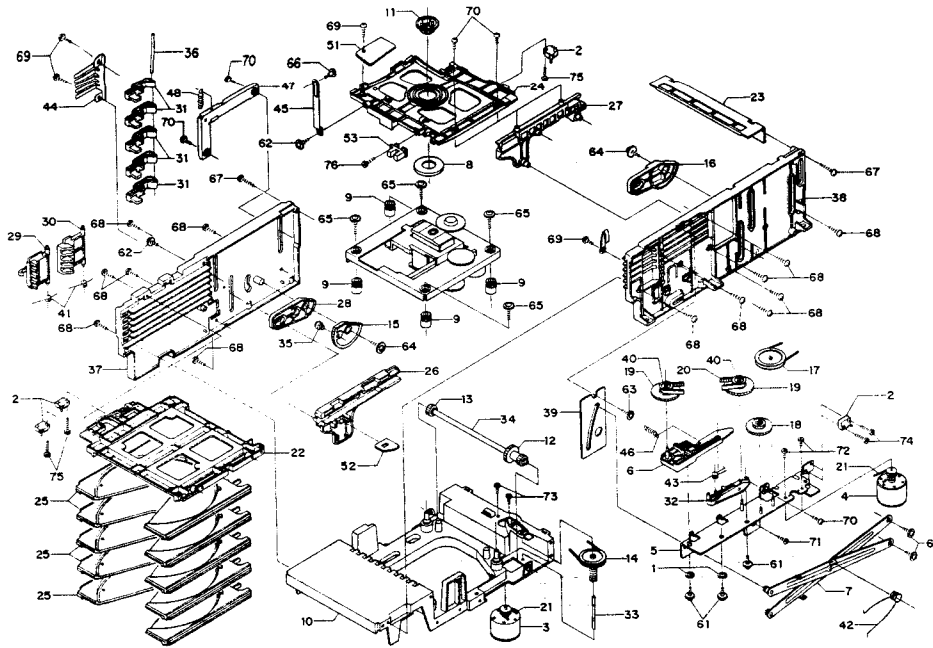

CD INDEX MECHANISM PARTS LIST

Ref. No.	Part No.	Description	Q'ty	Ref. No.	Part No.	Description	Q'ty
CD INDEX MECHANISM							
	141-2-2449-55200	Sheet	1	19	141-2-5519-73700	Gear Pinion	2
	141-2-4729-04200	Lug	1	20	141-2-5619-02800	Belt (Timing)	1
	141-2-4729-07100	Wire Band	7	21	141-2-5649-30300	Belt	2
1	141-2-4579-05900	Washer, M4.7x9.0x0.13	2	22	141-2-6229-01600	Support Front	1
2	4-2319-79910	Lever Switch (Open/Close) [SW1]	1	23	141-2-6229-01700	Support Rear	1
2	4-2319-79910	Lever Switch (Store Point) [SW2]	1	24	141-2-6229-01800	Flap Disc Cramp	1
2	4-2319-79910	Lever Switch (Loading Limit) [SW3]	1	25	141-2-7319-85800	Tray	5
2	4-2319-79910	Lever Switch (Playback Point) [SW4]	1	26	141-2-7319-85900	Slide Left	1
3	4-5279-71630	Motor (Index) [M3]	1	27	141-2-7319-86000	Slide Right	1
4	4-5279-71631	Motor Load (Load) [M4]	1	28	141-2-7429-05800	Lever Cam Left	1
5	141-0-7319-36100	Lever Index Assy	1	29	141-2-7429-05900	Lever Eject	1
6	141-0-7419-44200	Lever Index Assy	1	30	141-2-7429-06000	Lever Stop	1
7	141-0-7439-20900	Arm Index Assy	1	31	141-2-7429-06100	Lever Rock	5
8	141-0-8619-00300	Magnet Assy	1	32	141-2-7429-06200	Lever Adjust	1
9	141-2-4459-42000	Cushion Rubber	4	33	141-2-7519-83000	Shaft Gear Worm	1
10	141-2-3119-30200	Chassis (Load)	1	34	141-2-7519-83100	Shaft Index	1
11	141-2-3519-83800	Holder Disc	1	35	141-2-7519-83200	Pin Adjust	1
12	141-2-5519-73000	Gear Wormwheel	1	36	141-2-7519-83300	Shaft Lever Rock	1
13	141-2-5519-73100	Gear Index	1	37	141-2-8219-37500	Guide Left	1
14	141-2-5519-73200	Gear Worm	1	38	141-2-8219-37600	Guide Right	1
15	141-2-5519-73300	Gear Cam Left	1	39	141-2-8219-37700	Guide Plate	1
16	141-2-5519-73400	Gear Cam Right	1	40	141-2-8459-04900	Cap Gear Pinion	2
17	141-2-5519-73500	Gear Pulley	1	41	141-2-8529-39500	Spring Lever Stop	2
18	141-2-5519-73600	Gear Load	1	42	141-2-8529-39600	Spring Arm Index	1
				43	141-2-8529-39700	Spring Lever Adjust	1

CD INDEX PARTS LIST (Continued)

Ref. No.	Part No.	Description	Q'ty	Ref. No.	Part No.	Description	Q'ty
44	141-2-8539-61300	Spring Lever Rock	1	67	411 020 7007	SCR S-TPG BRZ 3X20	2
45	141-2-8539-61400	Spring Plate	1	68	411 020 5904	SCR S-TPG BRZ 3X10	13
46	141-2-8549-39200	Spring Lever Index	1	69	411 020 7700	SCR S-TPG BRZ 3X6	4
47	141-2-7319-89600	Slide Plate Left	1	70	411 020 5508	SCR S-TPG BRZ 2.6X6	5
48	141-2-8549-41900	Spring Slide Plate Left	1	71	411 022 1904	SCR S-TPG FLT 2.6X6	1
				72	411 031 0103	SCR BIN 2.6X3	2
51	141-0-1939-19830	LED P.C.B. Assy	1	73	411 031 0905	SCR BIN 2.6X4	2
52	141-0-1939-19840	Photo Transistor P.C.B. Assy	1	74	411 030 7707	SCR BIN 2X8	2
53	141-0-1939-19850	Photo Sensor P.C.B. Assy	1	75	411 063 7309	SCR TPG BIN 2X10	3
				76	411 063 8504	SCR TPG BIN 2X8	1
61	141-2-4219-04200	Screw	5	NOTES:			
62	141-2-4219-05400	Screw Washer	2	1. Parts order must contain Model Number, Part Number and Description.			
63	131-2-4201-28201	Screw (b Tite Sems)	1	2. Ordering quantity of screws and resistors must be multiple of 10 pcs.			
64	131-2-4201-28300	Screw (b Tite Sems) Z	2				
65	141-2-4219-44800	+BRTS-8 M2.6X14 Sems	4				
66	141-2-4219-23000	Screw	1				

SAFETY CERTIFICATION

This Compact Disc Player is made and tested to meet exacting safety standards. It meets UL and FCC requirements and complies with safety performance standards of the U.S. Department of Health and Human Services.

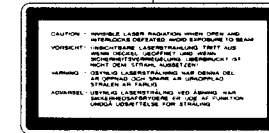
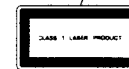
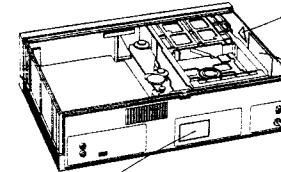

CAUTION - USE OF CONTROLS OR ADJUSTMENTS OR PERFORMANCE OF PROCEDURES OTHER THAN THOSE SPECIFIED HEREIN MAY RESULT IN HAZARDOUS RADIATION EXPOSURE.

THE COMPACT DISC PLAYER SHOULD NOT BE ADJUSTED OR REPAIRED BY ANYONE EXCEPT QUALIFIED SERVICE PERSONNEL.

LASER BEAM RADIATION SPOT

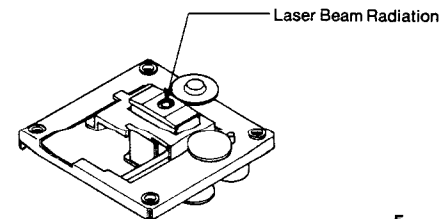

Laser Diode Properties
 Material : Ga-Al-As
 Wavelength : 755 - 815 nm (25°C)
 Laser Output : Continuous Wave max. 0.5 mW

CD MECHANISM EXPLODED VIEW

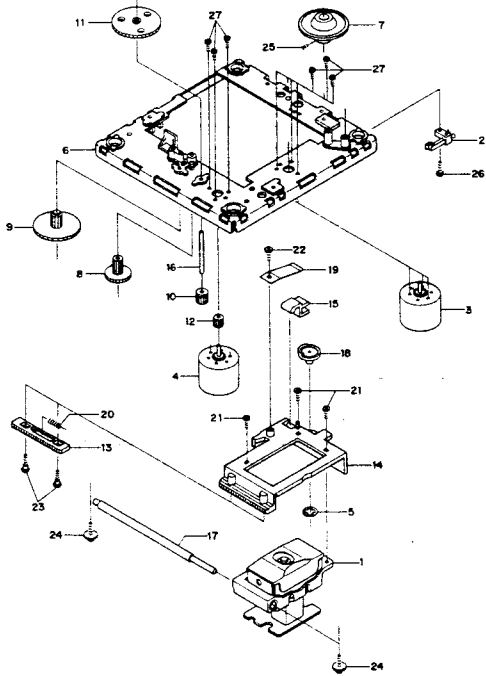

CD MECHANISM PARTS LIST

Ref. No.	Part No.	Description	Q'ty
CD MECHANISM			
1	134-0-4009-04001	Pick-up Assy T 84.5	1
2	4-2319-78750	Leaf Switch (Pick-up Limit) [SW7]	1
3	4-5279-71421	Motor (Disc) [M2]	1
4	4-5279-71431	Motor (Sied) [M1]	1
5	131-2-4220-10507	Ring Snap	1
6	141-0-3119-26601	Chassis Assy	1
7	141-2-5229-01300	Turntable	1
8	141-2-5519-66400	Gear Pick-up	1
9	141-2-5519-66500	Gear Load D	1
10	141-2-5519-66600	Gear Pinion	1
11	141-2-5519-66700	Gear Load S	1
12	141-2-5519-66800	Gear Motor	1
13	141-2-5519-67000	Gear Support Pick-up	1
14	141-2-7319-76000	Slide Base Pick-up	1
15	141-2-7319-76100	Slide	1
16	141-2-7519-76600	Shaft Gear Load S	1
17	141-2-7519-76700	Shaft Pick-up	1
18	141-2-8259-13800	Guide Slide Base Pl	1
19	141-2-8539-57500	Spring Plate	1
20	141-2-8559-15100	Spring Slide Base P	1
21	411 031 1605	SCR BIN 2.6X6	3
22	411 021 2704	SCR S-TPG BIN 2.6X6	1
23	141-2-4219-42300	Screw	2
24	141-2-4219-05400	Screw Washer M2.0x4	2
25	141-2-4219-36700	Set Screw V-cone M2.0X4	1
26	411 023 3303	SCR S-TPG PAN 2.6X8	1
27	411 019 9401	SCR PAN PCS 1.7X2.5	6

NOTES:

- Parts order must contain Model Number, Part Number and Description.
- Ordering quantity of screws and resistors must be multiple of 10 pcs.

ADJUSTMENT PROCEDURES

PRECAUTIONS REGARDING ADJUSTMENT

- Adjustment is performed in the indicated order.
- When adjustment is made for one item, check the other items which follow.
- The laser pick-up has already been precisely adjusted. Do not touch its mounting screws controls.

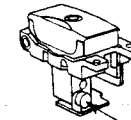

Do not Adjust

- Refer to the schematic diagram and printed circuit board.
- The ground point for the measurement equipment is the test point indicated as **GND**.

REQUIRED EQUIPMENTS

- DC Voltmeter
- Dualtrace Oscilloscope
- Frequency Counter
- Signal Generator
- Plastic Screwdriver
- Diffraction Grating Adjustment Jig
- Test Disc (SONY:YEDS4)
- Test Disc (SONY:YEDS7)

CHECKING FOCUS ERROR SIGNAL

Checking the focus error signal of the pick-up allows for an evaluation of the pick-up. Be sure this is carried out before repair.

- Turn on the power switch and set the unit to the STOP mode.
- Connect an oscilloscope between test pin **FE** of connector CN15 and test pin **GND**. (Set the time axis to 0.5 seconds/division.)
- Connect the +10V supply voltage to test pin **TP3** through a 47kΩ resistor.

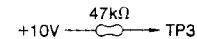

- Press the EJECT 1 button and place the test disc YEDS4 on the table load. Press the PLAY button.
- The waveform shown below is displayed six times on the oscilloscope. Check that the p-p voltage is about 8V and that the top and bottom of the waveform are symmetrical.

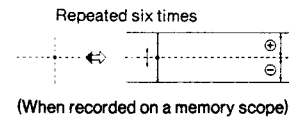

- This allows for confirmation to be made. The pick-up is faulty if confirmation cannot be made.

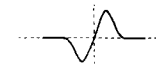

* p-p voltage of 8V
* + and - voltage roughly same

SETTING OF INITIAL POSITION OF VOLUME

- The variable resistors are set to the following initial positions.

P101 (E-F BALANCE)	Mechanical Center
P102 (FOCUS GAIN)	Mechanical Center
P103 (TRACKING GAIN)	Mechanical Center
P104 (KICK GAIN)	Mechanical Center
P105 (FOCUS OFFSET)	Mechanical Center
P106 (TRACKING OFFSET)	Mechanical Center
P107 (DAC)	Mechanical Center

FREE RUN FREQUENCY ADJUSTMENT

- Turn on the power switch and set the unit to the STOP mode.
- Connect the frequency counter between test pin **VCO** of connector CN10 and test pin **GND** (use probes).
- Rotate the core of the PLL OSC coil (T102) with a plastic screwdriver so that the frequency counter indicates 4.3218MHz.

FOCUS OFFSET ADJUSTMENT

- Turn on the power switch and set the unit to the STOP mode.
- Connect a DC Voltmeter and oscilloscope between test pin **FC** of connector CN14 and test pin **GND**.
- Adjust P105 so that the indication on the DC Voltmeter and oscilloscope is $0V \pm 10mV$.

TRACKING OFFSET ADJUSTMENT

- Turn on the power switch and set the unit to the STOP mode.
- Connect a DC Voltmeter and oscilloscope between test point **TC** of connector CN14 and test pin **GND**.
- Adjust P106 so that the indication on the DC Voltmeter and oscilloscope is $0V \pm 50mV$.

NOTE:

This adjustment should be made again after the adjustment of Tracking Gain.

ADJUSTMENT OF DIFFRACTION GRID

This unit uses a three beam method for the laser pick-up. Diffraction grid adjustment involves adjusting the position of the E and F beams in relation to the main beam so that they are in the same line.

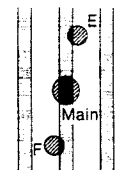

The following is the adjustment procedure. This is a precise adjustment and must be made carefully.

- Turn on the power switch, place test disc YEDS4 on the table load and set the unit to the STOP mode.
- Short test pins **TEST1** and **GND** of connector CN16.
- Short test pin **TP1** and test pin **GND**. Pass test pins **E** (TP13) and **F** (TP14) through the band pass filter, and connect to the channels of the dualtrace oscilloscope. The ground is obtained from test point **GND**.

ADJUSTMENT PROCEDURES (Continued)

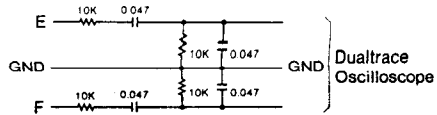

- Press the F FWD button. The TRACK No. indication is "2" and the disc begins to rotate. Continue to press the PLAY button. The unit is rotating in this state with the tracking servo turned off.
- Observe the resurge waveform of the waveform indicated on the oscilloscope and insert the adjustment jig into the diffraction grid holes to adjust the diffraction grid so that the phase difference is 180°.

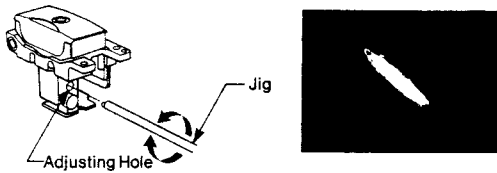

- Even if the phase difference is 180° in the above step, the E and F beams may be mistakenly on two different beam pit lines as shown below.

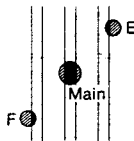

Be sure that the E and F beams are in the same pit line for subsequent adjustments.

- Remove the short between test pin TP1 and GND, and TEST 1 and GND, and play back the fourth selection on YEDS4.
- Observe the waveform of the signal between test pin E and test pin F using the dualtrace oscilloscope (Monitored in ALT mode). The beam E and beam F are in the same pit line if the trigger of waveform F is approximately 25μs behind the point (Position where waveform hollows out) where the waveform E is triggered.

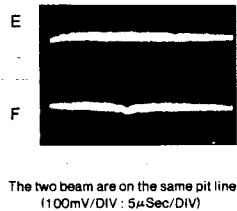

When observation of the waveform is difficult, the trigger level can be varied. When the beams are not in the same line, return to step 1, and rotate the adjustment jig at the 180° point. Confirm that the beams are in line at the 180° point. Repeat steps 1 to 7 until confirmation of this is possible.

Note:

When the pick-up is replaced, it is adjusted as a unit, and beams E and F can be brought in line and the phase made 180° by a slight adjustment. Slightly rotate the adjustment jig when making adjustment. If the beams come out of line, it is difficult to bring them back into the same pit line.

ADJUSTMENT OF PICK-UP ANGLE

- Mount the test disc YEDS4 on the turntable.
- Turn on the power and play back the fourth selection.
- Connect the oscilloscope between test pin HF and test pin GND. Monitor the waveform of HF and rotate the angle adjustment screw so that the waveform is at its maximum.

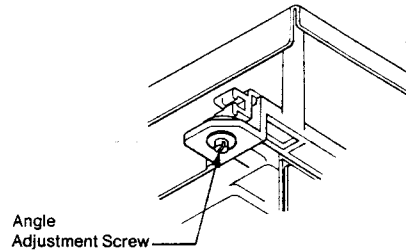

E-F BALANCE ADJUSTMENT

- Turn on the power switch and mount test disc YEDS4 on the table load. Set the unit to the STOP mode.
- Short test pins TEST1 and GND of connector CN16.
- Short test pin TP1 and test pin GND, and connect a DC Voltmeter and oscilloscope to test pin TE of connector CN15 through the low-pass filter shown below.

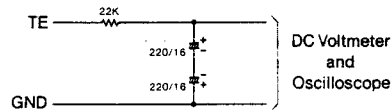

- Press the F FWD button. The TRACK No. indication is "2" and the disc begins to rotate. Continue to press the PLAY button. The unit is rotating in this state with the tracking servo turned off.
- Adjust P101 so that the DC Voltmeter and oscilloscope is $0V \pm 15mV$.

ADJUSTMENT PROCEDURES (Continued)

ADJUSTMENT OF TURNTABLE HEIGHT

This adjustment must be made when the motor is replaced.

- Attach the turntable so that its top surface is 11.9mm from the top of the chassis.

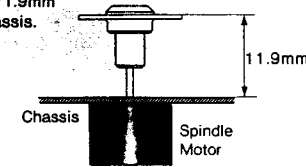

- Connect test pin FC of connector CN14 to a DC Voltmeter and oscilloscope through the low-pass filter.

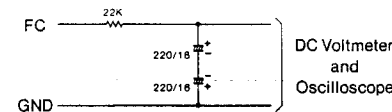

- Turn on the power switch and playback the first selection on test disc YEDS4.
- Readjust the height of the turntable if the reading on the DC Voltmeter is not in the range of $0V \pm 0.25V$. (Increase the height of the turntable when the DC Voltmeter reading is positive, and decrease it when negative.)

ADJUSTMENT OF FOCUS/TRACKING GAIN

The measurement circuit shown below is necessary for accurate adjustment of the focus and tracking gain. If this circuit cannot be made, make adjustments using the simplified procedure.

- Remove connector CN5 from the pick-up and connect the measurement circuit between the PCB and pick-up.
- The IC used is TA7256P.
- Volume control 2kΩ-B shorts IN and SG. 1kHz 1Vp-p is supplied from the signal generator, and adjustment is made for minimum output from OUT.

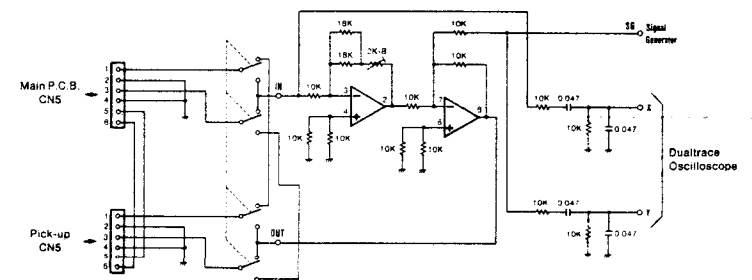

Simplified adjustment Procedure

- Focus gain adjustment P102 is set to a mechanical center.
- Tracking gain adjustment P103 is set to a mechanical center.

Precise adjustment procedure

- Focus gain adjustment
 - Connect the measurement circuit shown above, turn on the power switch, and mount the test disc YEDS4.
 - Playback the first selection on the test disc, and apply a 1,000Hz 0.5Vp-p signal from the signal generator.
 - Observe the resurge waveforms on the oscilloscope, and adjust P102 so that the phase difference of outputs X and Y from the measurement circuit is 90°.
- Tracking gain adjustment
 - Adjustment is made in the same manner as for focus gain. The input from the frequency generator is set to 1,000Hz, 0.5Vp-p, and P103 is adjusted so that the phase difference is 90°.

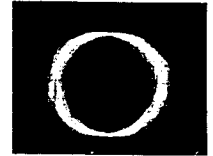

ADJUSTMENT PROCEDURES (Continued)

ADJUSTMENT OF KICK GAIN

- Load the test disc YEDS4 on the turntable.
- Set the oscilloscope at the NORMAL TRIG. and connect the TRHD of connector CN16 to the external trigger terminal. Then, connect the channels, 1 and 2, to the test pin, HF and TE, respectively.
- Switch on the power. In the start of playing the first tune, make it pause and observe the waveforms of HF and TE triggered by TRHD.
- Adjust the P104 for making a track jump between 1 and 1.5 track.

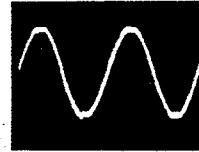

Proper Waveform

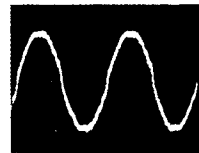

Interrupted Waveform

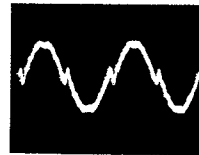

Interrupted Waveform

HF
1V/DIV
50μSec/DIV

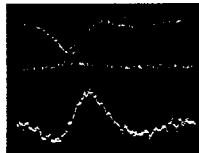

TE
0.5V/DIV
50μSec/DIV

HF
1V/DIV
50μSec/DIV

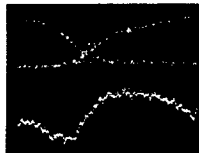

TE
0.5V/DIV
50μSec/DIV

Waveform showing short Kick Gain

HF
1V/DIV
50μSec/DIV

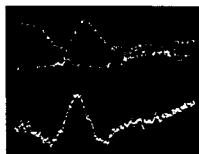

TE
0.5V/DIV
50μSec/DIV

Waveform showing Excessive Kick Gain

ADJUSTMENT OF DAC

- Connect the outlet of the unit to the oscilloscope.
- Turn on the power and mount the test disc YEDS2 on the table load.
- Play back the twentieth selection (1kHz: -60dB) on the test disc and apply a reasonable output to the oscilloscope with the volume knob of the premain amplifier.
- Adjust the P107 for getting sine waveform on the oscilloscope.

P.C. BOARD PARTS LIST

Ref. No.	Part No.	Description	Q'ty	Ref. No.	Part No.	Description	Q'ty
MAIN P.C.B. ASSY							
31	141-0-1939-20515	Main P.C.B. Assy	1	D115	407 061 2200	DIODE 1SS254-TA	1
	111-2-622C-11100	Wire Wrap Terminal	14	or	407 007 9904	DIODE GMA01-BT	1
	141-2-3229-60200	Plate Earth	1	D116	407 061 2200	DIODE 1SS254-TA	1
	4-2352-01940	Fuse Clip	8	or	407 007 9904	DIODE GMA01-BT	1
	△ 4-2349-20131	Fuse T400mA	2	D117	407 061 2200	DIODE 1SS254-TA	1
	△ 4-2349-70040	Fuse T500mA	2	or	407 007 9904	DIODE GMA01-BT	1
CN1	4-2352-02520	Socket 13P	1	D118	407 061 2200	DIODE 1SS254-TA	1
CN2	4-2352-02510	Socket 6P	1	or	407 007 9904	DIODE GMA01-BT	1
CN3	4-2352-02500	Socket 7P	1	D120	407 005 3805	DIODE DS442-BT	1
CN4	4-2369-74990	Plug 8P	1	D121	407 000 3503	VARACTOR DI SVC211SP	1
CN5	4-2369-74920	Plug 6P	1	D122	407 061 1500	DIODE 1SR35	1
CN6	4-2369-73160	Plug 6P	1	D123	407 061 1500	DIODE 1SR35	1
CN7	4-2362-00770	Plug 2P	1	D124	407 061 1500	DIODE 1SR35	1
CN8	4-2369-73140	Plug 4P	1	D125	407 061 1500	DIODE 1SR35	1
CN9	4-2369-73150	Plug 5P	1	D126	407 061 1500	DIODE 1SR35	1
CN10	4-2369-75120	Plug 6P	1	D127	407 061 1500	DIODE 1SR35	1
CN11	4-2369-73160	Plug 6P	1	D128	407 061 1500	DIODE 1SR35	1
CN13	4-2369-75840	Plug 9P	1	D129	407 061 1500	DIODE 1SR35	1
CN14	4-2369-72820	Plug 5P	1	D130	407 061 2200	DIODE 1SS254-TA	1
CN15	4-2369-71851	Plug 4P	1	or	407 007 9904	DIODE GMA01-BT	1
CN16	4-2369-71861	Plug 8P	1	D131	407 061 2200	DIODE 1SS254-TA	1
CN17	4-2369-71482	Plug 3P	1	or	407 007 9904	DIODE GMA01-BT	1
CN18	4-2369-76010	Plug 5P	1	D132	407 061 2200	DIODE 1SS254-TA	1
CN21	4-2369-73130	Plug 3P	1	or	407 007 9904	DIODE GMA01-BT	1
CN22	4-2369-73130	Plug 3P	1	D133	407 049 9504	ZENER DIODE GZA20Y	1
JK101	4-2352-01631	Pin Jack 2P (LINE OUT)	1	D134	407 050 4802	ZENER DIODE GZA5.1Y	1
L101	4-2525-70460	Filter WIP2005B8	1	D135	407 061 2200	DIODE 1SS254-TA	1
L102	4-2539-71420	Choke Coil (100μH)	1	or	407 007 9904	DIODE GMA01-BT	1
T101	4-2539-72160	RF Filter	1	D136	407 050 7704	ZENER DIODE GZA9.1Y	1
T102	4-2589-73250	OSC Coi	1	D137	407 050 7704	ZENER DIODE GZA9.1Y	1
P101	4-2229-76740	Potentiometer (B-100kΩ)	1	D138	407 061 2200	DIODE 1SS254-TA	1
P102	4-2229-76561	Potentiometer (B-10kΩ)	1	or	407 007 9904	DIODE GMA01-BT	1
P103	4-2229-76561	Potentiometer (B-10kΩ)	1	D139	407 061 2200	DIODE 1SS254-TA	1
P104	4-2229-76563	Potentiometer (B-200kΩ)	1	or	407 007 9904	DIODE GMA01-BT	1
P105	4-2229-76560	Potentiometer (B-100kΩ)	1	IC101	409 004 8300	IC CX20109	1
P106	4-2229-76562	Potentiometer (B-20kΩ)	1	IC102	409 018 5500	IC LA6510	1
P107	4-2229-76740	Potentiometer (B-100kΩ)	1	or	409 071 4403	IC TA7256P	1
X101	4-2259-71010	Crystal	1	IC103	409 018 4206	IC LA6393S	1
D101	407 061 2200	DIODE 1SS254-TA	1	or	409 039 6401	IC NJM2903S	1
or	407 007 9904	DIODE GMA01-BT	1	or	409 049 4305	IC TA75393S	1
D102	407 061 2200	DIODE 1SS254-TA	1	IC104	409 057 4601	IC UPC4570HA	1
or	407 007 9904	DIODE GMA01-BT	1	IC105	409 057 4601	IC UPC4570HA	1
D103	407 061 2200	DIODE 1SS254-TA	1	IC106	409 073 0304	IC YM3815	1
or	407 007 9904	DIODE GMA01-BT	1	IC107	409 020 6205	IC LC3517AM-15	1
D104	407 005 3805	DIODE DS442-BT	1	or	409 072 0008	IC TC6517BF-20	1
D105	407 061 2200	DIODE 1SS254-TA	1	or	409 059 6702	IC UPD446G-20	1
or	407 007 9904	DIODE GMA01-BT	1	or	409 004 5903	IC CXK5816M-15L	1
D106	407 061 2200	DIODE 1SS254-TA	1	or	409 012 5209	IC HM6116FP-4	1
or	407 007 9904	DIODE GMA01-BT	1	or	409 072 5003	IC TMM2116BF	1
D107	407 061 2200	DIODE 1SS254-TA	1	IC108	409 070 7009	IC PCM56P	1
or	407 007 9904	DIODE GMA01-BT	1	IC109	409 051 3006	IC TC4053BP	1
D108	407 061 2200	DIODE 1SS254-TA	1	or	409 070 1106	IC MSM4053BRS	1
or	407 007 9904	DIODE GMA01-BT	1	IC110	409 057 4403	IC UPC4570C	1
D109	407 061 2200	DIODE 1SS254-TA	1	IC111	409 057 4403	IC UPC4570C	1
or	407 007 9904	DIODE GMA01-BT	1	IC112	409 018 5500	IC LA6510	1
D110	407 061 2200	DIODE 1SS254-TA	1	or	409 071 4403	IC TA7256P	1
or	407 007 9904	DIODE GMA01-BT	1	IC113	409 072 9506	IC UPD74HCU04C	1
D111	407 061 2200	DIODE 1SS254-TA	1	or	409 052 1407	IC TC74HCU04P	1
or	407 007 9904	DIODE GMA01-BT	1	or	409 022 0805	IC LC74HCU04	1
D112	407 061 2200	DIODE 1SS254-TA	1	or	409 110 4807	IC NJU74HCU04D	1
or	407 007 9904	DIODE GMA01-BT	1	IC114	409 074 2208	IC NJM79M06A	1
D113	407 061 2200	DIODE 1SS254-TA	1	or	409 118 0108	IC NJM79M06FA	1
or	407 007 9904	DIODE GMA01-BT	1	or	409 074 0204	IC AN79M06	1
D114	407 061 2200	DIODE 1SS254-TA	1	or	409 074 0303	IC AN79M06F	1
or	407 007 9904	DIODE GMA01-BT	1	or	409 074 2000	IC NJM7906A	1
				or	409 074 2109	IC NJM7906FA	1

P.C. BOARD PARTS LIST (Continued)

Ref. No.	Part No.	Description	Q'ty	Ref. No.	Part No.	Description	Q'ty
IC115	409 050 0501	IC TA78L006AP	1	C131	403 086 2706	NP-ELECT 1U M 50V	1
IC118	409 020 8704	IC LC4066B	1	C132	403 038 7209	ELECT 220U M 6.3V	1
Q101	405 024 9907	TR 2SD734-F	1	C133	403 050 1209	ELECT 2.2U M 50V	1
Q102	405 004 4502	TR 2SA608-F-NP	1	C134	403 026 9406	CERAMIC 5P C 50V	1
Q103	405 004 4502	TR 2SA608-F-NP	1	C135	403 038 2303	ELECT 100U M 6.3V	1
Q104	405 033 7000	TR 2SD1676	1	C136	403 042 3501	ELECT 100U M 16V	1
Q105	405 033 7000	TR 2SD1676	1	C137	403 042 3501	ELECT 100U M 16V	1
Q106	405 033 5006	TR 2SD1227-M	1	C138	403 086 2706	NP-ELECT 1U M 50V	1
Q107	405 027 0505	TR 2SK246-GR	1	C139	403 086 2706	NP-ELECT 1U M 50V	1
Q108	405 033 5006	TR 2SD1227-M	1	C140	403 002 3602	CERAMIC 0.1U K 25V	1
Q109	405 033 5006	TR 2SD1227-M	1	C141	403 002 3602	CERAMIC 0.1U K 25V	1
Q110	405 027 0505	TR 2SK246-GR	1	C142	403 072 2703	CERAMIC 0.022U Z 50V	1
Q111	405 032 3102	TR 2SB911-M	1	C143	403 072 2703	CERAMIC 0.022U Z 50V	1
Q112	405 032 3102	TR 2SB911-M	1	C144	403 039 2906	ELECT 47U M 6.3V	1
Q113	405 032 3102	TR 2SB911-M	1	C145	403 072 2703	CERAMIC 0.022U Z 50V	1
Q114	405 019 2708	TR 2SC536-F-NP	1	C146	403 038 2303	ELECT 100U M 6.3V	1
Q115	405 019 2708	TR 2SC536-F-NP	1	C147	403 074 2701	CERAMIC 0.047U Z 50V	1
Q116	405 004 4502	TR 2SA608-F-NP	1	C148	403 057 0908	POLYESTER 0.01U K 50V	1
Q117	405 004 4502	TR 2SA608-F-NP	1	C149	403 087 2507	STYRENE 1000P J 50V	1
Q118	405 021 0600	TR 2SD1012-G-SPA	1	C150	403 060 6607	POLYESTER 3300P K 50V	1
Q119	405 021 0600	TR 2SD1012-G-SPA	1	C151	403 018 8509	CERAMIC 220P K 50V	1
Q120	405 019 2708	TR 2SC536-F-NP	1	C152	403 026 8201	CERAMIC 470P K 50V	1
Q121	405 019 2708	TR 2SC536-F-NP	1	C153	403 039 2906	ELECT 47U M 6.3V	1
Q122	405 021 0600	TR 2SD1012-G-SPA	1	C154	403 039 2906	ELECT 47U M 6.3V	1
Q123	405 033 7000	TR 2SD1676	1	C155	403 022 0902	CERAMIC 30P J 50V	1
Q124	405 033 7000	TR 2SD1676	1	C156	403 022 0902	CERAMIC 30P J 50V	1
Q125	405 021 0600	TR 2SD1012-G-SPA	1	C157	403 040 4708	ELECT 220U M 10V	1
Q126	405 021 0600	TR 2SD1012-G-SPA	1	C158	403 040 4708	ELECT 220U M 10V	1
Q127	405 004 3901	TR 2SA608-E-NP	1	C159	403 050 7706	ELECT 3.3U M 50V	1
Q128	405 018 2600	TR 2SC3400	1	C160	403 050 7706	ELECT 3.3U M 50V	1
Q129	405 032 8206	TR 2SC1846-Q	1	C161	403 086 2706	NP-ELECT 1U M 50V	1
Q130	405 024 9907	TR 2SD734-F	1	C162	403 088 3107	STYRENE 390P J 50V	1
Q131	405 034 7603	TR DTA124	1	C163	403 088 3107	STYRENE 390P J 50V	1
or	405 001 1207	TR RN2203	1	C164	403 060 1008	POLYESTER 2700P K 50V	1
Q132	405 018 2600	TR 2SC3400	1	C165	403 060 1008	POLYESTER 2700P K 50V	1
Q135	405 004 3901	TR 2SA608-E-NP	1	C166	403 088 7402	STYRENE 82P J 50V	1
C101	403 057 0908	POLYESTER 0.01U K 50V	1	C167	403 088 7402	STYRENE 82P J 50V	1
C102	403 018 4204	CERAMIC 22P K 50V	1	C168	403 041 3304	ELECT 47U M 10V	1
C103	403 018 4204	CERAMIC 22P K 50V	1	C169	403 041 3304	ELECT 47U M 10V	1
C104	403 072 2703	CERAMIC 0.022U Z 50V	1	C170	403 039 2906	ELECT 47U M 6.3V	1
C105	403 039 2906	ELECT 47U M 6.3V	1	C171	403 041 3304	ELECT 47U M 10V	1
C106	403 050 7706	ELECT 3.3U M 50V	1	C172	403 074 2701	CERAMIC 0.047U Z 50V	1
C107	403 067 7201	MT-COMPO 0.033U J 50V	1	C173	403 041 3304	ELECT 47U M 10V	1
C108	403 048 7602	ELECT 0.47U M 50V	1	C174	403 058 1607	POLYESTER 1500P K 50V	1
C109	403 031 0306	CERAMIC 68P K 50V	1	C175	403 058 1607	POLYESTER 1500P K 50V	1
C110	403 031 0306	CERAMIC 68P K 50V	1	C176	403 041 3304	ELECT 47U M 10V	1
C111	403 038 2303	ELECT 100U M 6.3V	1	C177	403 041 3304	ELECT 47U M 10V	1
C112	403 038 2303	ELECT 100U M 6.3V	1	C178	403 085 6408	NP-ELECT 4.7U M 16V	1
C113	403 069 8404	CERAMIC 0.01U Z 50V	1	C179	403 085 6408	NP-ELECT 4.7U M 16V	1
C114	403 067 5603	MT-COMPO 0.1U J 50V	1	C180	403 056 8608	POLYESTER 1000P K 50V	1
C115	403 018 4204	CERAMIC 22P K 50V	1	C181	403 056 8608	POLYESTER 1000P K 50V	1
C116	403 067 5603	MT-COMPO 0.1U J 50V	1	C182	403 040 4708	ELECT 220U M 10V	1
C117	403 026 8201	CERAMIC 470P K 50V	1	C183	403 042 0302	ELECT 10U M 16V	1
C118	403 086 2706	NP-ELECT 1U M 50V	1	C184	403 038 2303	ELECT 100U M 6.3V	1
C119	403 085 6408	NP-ELECT 4.7U M 16V	1	C185	403 038 2303	ELECT 100U M 6.3V	1
C120	403 028 9408	CERAMIC 5P C 50V	1	C186	403 038 2303	ELECT 100U M 6.3V	1
C121	403 042 3501	ELECT 100U M 16V	1	C187	403 072 2703	CERAMIC 0.022U Z 50V	1
C122	403 042 3501	ELECT 100U M 16V	1	C188	403 072 2703	CERAMIC 0.022U Z 50V	1
C123	403 057 0908	POLYESTER 0.01U K 50V	1	C189	403 038 2303	ELECT 100U M 6.3V	1
C124	403 038 9302	ELECT 33U M 6.3V	1	C190	403 040 4708	ELECT 220U M 10V	1
C125	403 038 2303	ELECT 100U M 6.3V	1	C191	403 072 2703	CERAMIC 0.022U Z 50V	1
C126	403 038 2303	ELECT 100U M 6.3V	1	C192	403 040 4708	ELECT 220U M 10V	1
C127	403 057 8003	POLYESTER 0.012U K 50V	1	C193	403 072 2703	CERAMIC 0.022U Z 50V	1
C128	403 057 8003	POLYESTER 0.012U K 50V	1	C194	4-2239-72280	Elect 2200MF 25V	1
C129	403 059 4102	POLYESTER 2200P K 50V	1	C195	4-2239-72280	Elect 2200MF 25V	1
C130	403 059 4102	POLYESTER 2200P K 50V	1	C196	4-2239-72280	Elect 2200MF 25V	1

P.C. BOARD PARTS LIST (Continued)

Ref. No.	Part No.	Description	Q'ty	Ref. No.	Part No.	Description	Q'ty
C197	4-2239-72280	Elect 2200MF 25V	1	R134	401 020 2904	CARBON 47K JA 1/4W	1
C198	403 072 2703	CERAMIC 0.022U Z 50V	1	R135	401 027 5908	CARBON 68K JA 1/6W	1
C199	403 072 2703	CERAMIC 0.022U Z 50V	1	R136	401 025 4903	CARBON 180K JA 1/6W	1
C200	403 072 2703	CERAMIC 0.022U Z 50V	1	R137	401 026 4308	CARBON 3.3K JA 1/6W	1
C201	403 072 2703	CERAMIC 0.022U Z 50V	1	R138	401 025 4200	CARBON 1.8K JA 1/6W	1
C202	403 038 2303	ELECT 100U M 6.3V	1	R139	401 020 2904	CARBON 47K JA 1/4W	1
C203	403 044 8207	ELECT 10U M 25V	1	R140	401 025 8208	CARBON 22K JA 1/6W	1
C204	403 051 2007	ELECT 4.7U M 50V	1	R141	401 025 8208	CARBON 22K JA 1/6W	1
C205	403 060 1008	POLYESTER 2700P K 50V	1	R142	401 025 1902	CARBON 15K JA 1/6W	1
C206	403 067 8208	MT-COMPO 0.068U J 50V	1	R143	401 025 1605	CARBON 1.5K JA 1/6W	1
C207	403 031 0306	CERAMIC 68P K 50V	1	R144	401 024 8001	CARBON 1M JA 1/6W	1
C208	403 002 3602	CERAMIC 0.1U K 25V	1	R145	401 024 7400	CARBON 10K JA 1/6W	1
C209	403 002 3602	CERAMIC 0.1U K 25V	1	R146	401 024 7400	CARBON 10K JA 1/6W	1
C210	403 039 2906	ELECT 100U M 10V	1	R147	401 024 7400	CARBON 10K JA 1/6W	1
C211	403 039 2906	ELECT 100U M 10V	1	R148	401 024 7400	CARBON 10K JA 1/6W	1
C212	403 044 0201	ELECT 47U M 16V	1	R149	401 027 0309	CARBON 47K JA 1/6W	1
C213	403 047 4206	ELECT 47U M 25V	1	R150	401 025 8208	CARBON 22K JA 1/6W	1
C214	403 023 1700	CERAMIC 33P K 50V	1	R151	401 025 8703	CARBON 220K JA 1/6W	1
C215	403 023 1700	CERAMIC 33P K 50V	1	R152	401 013 6407	CARBON 12K JA 1/4W	1
C216	403 072 2703	CERAMIC 0.022U Z 50V	1	R153	401 016 4806	CARBON 10K JA 1/6W	1
C217	403 072 2703	CERAMIC 0.022U Z 50V	1	R154	401 025 8208	CARBON 22K JA 1/6W	1
C218	403 072 2703	CERAMIC 0.022U Z 50V	1	R155	401 016 4806	CARBON 22K JA 1/4W	1
C219	403 072 2703	CERAMIC 0.022U Z 50V	1	R156	401 025 8208	CARBON 22K JA 1/6W	1
C220	403 072 2703	CERAMIC 0.022U Z 50V	1	R157	401 025 4606	CARBON 18K JA 1/6W	1
C221	403 072 2703	CERAMIC 0.022U Z 50V	1	R158	401 026 4605	CARBON 33K JA 1/6W	1
C222	403 072 2703	CERAMIC 0.022U Z 50V	1	R159	401 025 8703	CARBON 220K JA 1/6W	1
C223	403 074 2701	CERAMIC 0.047U Z 50V	1	R160	401 027 0507	CARBON 47K JA 1/6W	1
C224	403 072 2703	CERAMIC 0.022U Z 50V	1	R161	401 026 1307	CARBON 27K JA 1/6W	1
C225	403 074 2701	CERAMIC 0.047U Z 50V	1	R162	401 026 1307	CARBON 27K JA 1/6W	1
C226	403 074 2701	CERAMIC 0.047U Z 50V	1	R163	401 026 1604	CARBON 270K JA 1/6W	1
C227	403 068 9105	CERAMIC 100P K 50V	1	R164	401 012 8105	CARBON 100K JA 1/4W	1
C228	403 068 9105	CERAMIC 100P K 50V	1	R165	401 015 6504	CARBON 2.2K JA 1/4W	1
C229	403 068 9105	CERAMIC 100P K 50V	1	R166	401 026 1307	CARBON 27K JA 1/6W	1
C230	403 072 9603	CERAMIC 3300P K 50V	1	R167	401 026 1307	CARBON 27K JA 1/6W	1
R101	401 026 9907	CARBON 4.7K JA 1/6W	1	R168	401 025 7805	CARBON 68K JA 1/6W	1
R102	401 027 5205	CARBON 68K JA 1/6W	1	R169	401 027 3201	CARBON 560K JA 1/6W	1
R103	401 026 1307	CARBON 27K JA 1/6W	1	R170	401 027 3201	CARBON 560K JA 1/6W	1
R104	401 025 4903	CARBON 180K JA 1/6W	1	R171	401 027 3003	CARBON 10K JA 1/6W	1
R105	401 025 0905	CARBON 130K JA 1/6W	1	R172	401 012 8105	CARBON 100K JA 1/4W	1
R106	401 024 7004	CARBON 1K JA 1/6W	1	R173	401 012 8105	CARBON 100K JA 1/4W	1
R107	401 024 7707	CARBON 100K JA 1/6W	1	R174	401 026 4902	CARBON 330K JA 1/6W	1
R108	401 024 7707	CARBON 100K JA 1/6W	1	R175	401 025 8208	CARBON 22K JA 1/6W	1
R109	401 025 7805	CARBON 2.2K JA 1/6W	1	R176	401 025 8208	CARBON 22K JA 1/6W	1
R110	401 025 8703	CARBON 220K JA 1/6W	1	R177	401 027 0309	CARBON 47K JA 1/6W	1
R111	401 024 7400	CARBON 10K JA 1/6W	1	R178	401 027 0309	CARBON 47K JA 1/6W	1
R112	401 024 7400	CARBON 10K JA 1/6W	1	R179	401 025 8208	CARBON 22K JA 1/6W	1
R113	401 025 7805	CARBON 2.2K JA 1/6W	1	R180	401 024 7707	CARBON 100K JA 1/6W	1
R114	401 024 7707	CARBON 100K JA 1/6W	1	R181	401 024 7707	CARBON 100K JA 1/6W	1
R115	401 025 0004	CARBON 120K JA 1/6W	1	R182	401 024 7400	CARBON 10K JA 1/6W	1
R116	401 027 3201	CARBON 560K JA 1/6W	1	R183	401 024 7400	CARBON 10K JA 1/6W	1
R117	401 027 9005	CARBON 82K JA 1/6W	1	R184	401 024 7400	CARBON 10K JA 1/6W	1
R118	401 016 3809	CARBON 2.2K JA 1/4W	1	R185	401 025 7805	CARBON 2.2K JA 1/6W	1
R119	401 025 8208	CARB					

P.C.BOARD PARTS LIST(Continued)

Ref. No.	Part No.	Description	Q'ty	Ref. No.	Part No.	Description	Q'ty
R200	401 025 3807	CARBON 180 JA 1/6W	1	R268	401 026 7002	CARBON 3.9K JA 1/6W	1
R201	401 012 1106	CARBON 1.5 JA 1/4W	1	R269	401 026 7002	CARBON 3.9K JA 1/6W	1
R202	401 043 9706	MT-FILM 1.8K FA 1/4W	1	R270	401 026 4605	CARBON 33K JA 1/6W	1
R203	401 025 4200	CARBON 1.8K JA 1/6W	1	R271	401 027 3201	CARBON 560K JA 1/6W	1
R204	401 024 6403	CARBON 10 JA 1/6W	1	R272	401 027 3201	CARBON 560K JA 1/6W	1
R205	401 024 6403	CARBON 10 JA 1/6W	1	R273	401 026 4605	CARBON 33K JA 1/6W	1
R206	401 024 7004	CARBON 1K JA 1/6W	1	R274	401 016 3809	CARBON 2.2K JA 1/4W	1
R207	401 026 4902	CARBON 330K JA 1/6W	1	R275	401 016 3809	CARBON 2.2K JA 1/4W	1
R208	401 025 8208	CARBON 22K JA 1/6W	1	R276	401 025 7805	CARBON 2.2K JA 1/6W	1
R209	401 027 0309	CARBON 47K JA 1/6W	1	R277	401 025 7805	CARBON 2.2K JA 1/6W	1
R210	401 024 7004	CARBON 1K JA 1/6W	1	R278	401 024 7707	CARBON 100K JA 1/6W	1
R211	401 026 4902	CARBON 330K JA 1/6W	1	R279	401 024 7707	CARBON 100K JA 1/6W	1
R212	401 025 8208	CARBON 22K JA 1/6W	1	R280	401 024 7004	CARBON 1K JA 1/6W	1
R213	401 025 8208	CARBON 22K JA 1/6W	1	R281	401 024 7004	CARBON 1K JA 1/6W	1
R214	401 025 8208	CARBON 22K JA 1/6W	1	R282	401 024 7400	CARBON 10K JA 1/6W	1
R215	401 025 8208	CARBON 22K JA 1/6W	1	R283	401 024 7400	CARBON 10K JA 1/6W	1
R216	401 025 8208	CARBON 22K JA 1/6W	1	R284	401 024 7707	CARBON 100K JA 1/6W	1
R217	401 025 8208	CARBON 22K JA 1/6W	1	R285	401 024 7707	CARBON 100K JA 1/6W	1
R218	401 025 8208	CARBON 22K JA 1/6W	1	R286	401 025 8208	CARBON 22K JA 1/6W	1
R221	401 025 8208	CARBON 22K JA 1/6W	1	R287	401 025 7409	CARBON 220 JA 1/6W	1
R222	401 025 8208	CARBON 22K JA 1/6W	1	R288	401 027 0309	CARBON 47K JA 1/6W	1
R223	401 024 7707	CARBON 100K JA 1/6W	1	R289	401 018 2800	CARBON 330 JA 1/4W	1
R224	401 024 7707	CARBON 100K JA 1/6W	1	R290	401 018 2800	CARBON 330 JA 1/4W	1
R225	401 025 2305	CARBON 150K JA 1/6W	1	R291	402 032 7703	FUSIBLE RES 22 JA 1/2W	1
R226	401 027 5908	CARBON 68K JA 1/6W	1	R292	402 016 5008	FUSIBLE RES 33 J-1/2W	1
R227	401 024 7004	CARBON 1K JA 1/6W	1	R293	401 063 0202	OXIDE-MT 68 JB 1W	1
R228	401 024 8001	CARBON 1M JA 1/6W	1	R294	401 063 0202	OXIDE-MT 68 JB 1W	1
R229	401 025 8208	CARBON 22K JA 1/6W	1	R295	401 025 8208	CARBON 22K JA 1/6W	1
R230	401 025 7409	CARBON 220 JA 1/6W	1	R296	401 025 7409	CARBON 220 JA 1/6W	1
R231	401 024 7707	CARBON 100K JA 1/6W	1	R297	401 027 2303	CARBON 560 JA 1/6W	1
R232	401 026 9907	CARBON 4.7K JA 1/6W	1	R300	402 016 4506	FUSIBLE RES 10 J-1/2W	1
R233	401 025 7805	CARBON 2.2K JA 1/6W	1	R301	402 016 4506	FUSIBLE RES 10 J-1/2W	1
R234	401 053 1301	MT-FILM 22K FA 1/6W	1	R302	401 022 1905	CARBON 680 JA 1/4W	1
R235	401 053 1301	MT-FILM 22K FA 1/6W	1	R303	401 024 7707	CARBON 100K JA 1/6W	1
R236	401 053 1301	MT-FILM 22K FA 1/6W	1	R304	401 012 5708	CARBON 1K JA 1/4W	1
R237	401 053 1301	MT-FILM 22K FA 1/6W	1	R305	401 016 5803	CARBON 220K JA 1/4W	1
R238	401 026 4308	CARBON 3.3K JA 1/6W	1				
R239	401 024 8001	CARBON 1M JA 1/6W	1				
R240	401 026 2403	CARBON 3.9 JA 1/6W	1				
R241	401 012 4503	CARBON 100 JA 1/4W	1				
R242	401 012 4503	CARBON 100 JA 1/4W	1				
R243	401 026 8108	CARBON 4.7 JA 1/6W	1				
R244	401 026 8108	CARBON 4.7 JA 1/6W	1				
R245	401 012 4503	CARBON 100 JA 1/4W	1				
R246	401 012 4503	CARBON 100 JA 1/4W	1				
R247	401 012 4503	CARBON 100 JA 1/4W	1				
R248	401 012 4503	CARBON 100 JA 1/4W	1				
R249	401 024 7707	CARBON 100K JA 1/6W	1				
R250	401 025 4903	CARBON 180K JA 1/6W	1				
R251	401 012 5708	CARBON 1K JA 1/4W	1				
R252	401 012 4503	CARBON 100 JA 1/4W	1				
R253	401 026 9907	CARBON 4.7K JA 1/6W	1				
R254	401 026 9907	CARBON 4.7K JA 1/6W	1				
R255	401 025 1605	CARBON 1.5K JA 1/6W	1				
R256	401 025 1605	CARBON 1.5K JA 1/6W	1				
R257	401 025 7409	CARBON 220 JA 1/6W	1				
R258	401 025 7409	CARBON 220 JA 1/6W	1				
R259	401 024 7400	CARBON 10K JA 1/6W	1				
R260	401 024 7400	CARBON 10K JA 1/6W	1				
R261	401 024 7400	CARBON 10K JA 1/6W	1				
R262	401 025 7805	CARBON 2.2K JA 1/6W	1				
R264	401 016 4806	CARBON 22K JA 1/4W	1				
R265	401 025 8208	CARBON 22K JA 1/6W	1				
R266	401 024 7400	CARBON 10K JA 1/6W	1				
R267	401 024 7400	CARBON 10K JA 1/6W	1				

P.C.BOARD PARTS LIST(Continued)

Ref. No.	Part No.	Description	Q'ty	Ref. No.	Part No.	Description	Q'ty
SW906	4-2319-78470	Tact Switch (Display)	1	D931	407 061 2200	DIODE 1SS254-TA	1
SW907	4-2319-78470	Tact Switch (6)	1	or	407 007 9904	DIODE 6MA01-BT	1
SW908	4-2319-78470	Tact Switch (B. Scan)	1	D932	407 061 2200	DIODE 1SS254-TA	1
SW909	4-2319-78470	Tact Switch (5)	1	or	407 007 9904	DIODE 6MA01-BT	1
SW910	4-2319-78470	Tact Switch (F. Scan)	1	IC901	410 026 8407	IC UPD75206G-516	1
SW911	4-2319-78470	Tact Switch (4)	1	IC902	409 072 5300	IC TMP4270N1	1
SW912	4-2319-78470	Tact Switch (3)	1	Q901	405 006 2704	TR 2SA937-R	1
SW913	4-2319-78470	Tact Switch (0)	1	Q902	405 006 2704	TR 2SA937-R	1
SW914	4-2319-78470	Tact Switch (2)	1	Q903	405 006 2704	TR 2SA937-R	1
SW915	4-2319-78470	Tact Switch (9)	1	Q904	405 006 2704	TR 2SA937-R	1
SW916	4-2319-78470	Tact Switch (1)	1	Q905	405 006 2704	TR 2SA937-R	1
SW917	4-2319-78470	Tact Switch (8)	1	Q906	405 006 2704	TR 2SA937-R	1
SW918	4-2319-78470	Tact Switch (index)	1	Q907	405 006 2704	TR 2SA937-R	1
SW919	4-2319-78470	Tact Switch (Eject 5)	1	Q908	405 006 2704	TR 2SA937-R	1
SW920	4-2319-78470	Tact Switch (Disc 1)	1	Q909	405 006 2704	TR 2SA937-R	1
SW921	4-2319-78470	Tact Switch (Disc 2)	1	Q910	405 006 2704	TR 2SA937-R	1
SW922	4-2319-78470	Tact Switch (Disc 3)	1	Q911	405 006 2704	TR 2SA937-R	1
SW923	4-2319-78470	Tact Switch (Disc 4)	1	Q912	405 006 2704	TR 2SA937-R	1
SW924	4-2319-78470	Tact Switch (Disc 5)	1	Q913	405 006 2704	TR 2SA937-R	1
SW925	4-2319-78470	Tact Switch (Repeat)	1	Q914	405 035 0207	TR DTCT43-EF	1
SW926	4-2319-78470	Tact Switch (Random Play)	1	Q915	405 035 0207	TR DTCT43-EF	1
SW927	4-2319-78470	Tact Switch (Intro Scan)	1	C901	403 074 2701	CERAMIC 0.047U Z 50V	1
SW928	4-2319-78470	Tact Switch (Clear)	1	R901	4-2219-71750	RMB-223J 22kΩx8	1
SW929	4-2319-78470	Tact Switch (Check)	1	R902	4-2219-71750	RMB-223J 22kΩx8	1
SW930	4-2319-78470	Tact Switch (Memory)	1	R903	4-2219-71750	RMB-223J 22kΩx8	1
SW931	4-2319-78470	Tact Switch (F. Forward)	1	R904	401 025 8208	CARBON 22K JA 1/6W	1
SW932	4-2319-78470	Tact Switch (F. Back)	1	R905	401 025 8208	CARBON 22K JA 1/6W	1
SW933	4-2319-78470	Tact Switch (Pause)	1	R906	401 025 8208	CARBON 22K JA 1/6W	1
SW934	4-2319-78470	Tact Switch (Play)	1	R907	401 025 8208	CARBON 22K JA 1/6W	1
SW935	4-2319-78470	Tact Switch (Stop)	1	R908	401 025 8208	CARBON 22K JA 1/6W	1
D901	407 027 7102	LED SLP-1538-01 (Disc 5)	1	R909	401 025 8208	CARBON 22K JA 1/6W	1
D902	407 027 7102	LED SLP-1538-01 (Disc 4)	1	R910	401 025 8208	CARBON 22K JA 1/6W	1
D903	407 027 7102	LED SLP-1538-01 (Disc 3)	1	R911	401 025 8208	CARBON 22K JA 1/6W	1
D904	407 027 7102	LED SLP-1538-01 (Disc 2)	1	R912	401 025 8208	CARBON 22K JA 1/6W	1
D905	407 027 7102	LED SLP-1538-01 (Disc 1)	1	R913	401 025 8208	CARBON 22K JA 1/6W	1
D906	407 062 9307	LED SLB-55VR3 (Intro Scan)	1	R914	401 025 8208	CARBON 22K JA 1/6W	1
D907	407 062 9307	LED SLB-55VR3 (Random Play)	1	R915	401 025 8208	CARBON 22K JA 1/6W	1
D908	407 062 9307	LED SLB-55VR3 (Repeat)	1	R916	401 025 8208	CARBON 22K JA 1/6W	1
D909	407 062 9307	LED SLB-55VR3 (Memory)	1	R917	401 025 8208	CARBON 22K JA 1/6W	1
D910	407 024 6405	LED SLF-102B (Pause)	1	R918	401 025 8208	CARBON 22K JA 1/6W	1
D911	407 024 7709	LED SLF-202B (Play)	1	R919	401 025 8208	CARBON 22K JA 1/6W	1
D912	407 005 3805	DIODE DS442-BT	1	R920	401 025 8208	CARBON 22K JA 1/6W	1
D913	407 005 3805	DIODE DS442-BT	1	R921	401 025 8208	CARBON 22K JA 1/6W	1
D914	407 005 3805	DIODE DS442-BT	1	R922	401 024 7004	CARBON 1K JA 1/6W	1
D915	407 005 3805	DIODE DS442-BT	1	R923	401 024 7004	CARBON 1K JA 1/6W	1
D916	407 005 3805	DIODE DS442-BT	1	R924	401 012 5708	CARBON 1K JA 1/4W	1
D917	407 005 3805	DIODE DS442-BT	1	R925	401 024 7004	CARBON 1K JA 1/6W	1
D918	407 005 3805	DIODE DS442-BT	1	R926	401 012 5708	CARBON 1K JA 1/4W	1
D919	407 005 3805	DIODE DS442-BT	1	R927	401 024 7004	CARBON 1K JA 1/6W	1
D920	407 005 3805	DIODE DS442-BT	1	R928	401 012 5708	CARBON 1K JA 1/4W	1
D921	407 005 3805	DIODE DS442-BT	1	R929	401 024 7004	CARBON 1K JA 1/6W	1
D922	407 005 3805	DIODE DS442-BT	1	R930	401 012 5708	CARBON 1K JA 1/4W	1
D923	407 005 3805	DIODE DS442-BT	1	R931	401 027 2303	CARBON 560 JA 1/6W	1
D924	407 061 2200	DIODE 1SS254-TA	1	R932	401 012 5708	CARBON 1K JA 1/4W	1
or	407 007 9904	DIODE 6MA01-BT	1	R933	401 025 7409	CARBON 2.2K JA 1/6W	1
D925	407 061 2200	DIODE 1SS254-TA	1	R934	401 025 7805	CARBON 2.2K JA 1/6W	1
or	407 007 9904	DIODE 6MA01-BT	1	R935	401 025 7805	CARBON 2.2K JA 1/6W	1
D926	407 061 2200	DIODE 1SS254-TA	1	or	407 007 9904	DIODE 6MA01-BT	1
or	407 007 9904	DIODE 6MA01-BT	1	D927	407 061 2200	DIODE 1SS254-TA	1
D927	407 061 2200	DIODE 1SS254-TA	1	or	407 007 9904	DIODE 6MA01-BT	1
or	407 007 9904	DIODE 6MA01-BT	1	D928	407 061 2200	DIODE 1SS254-TA	1
D928	407 061 2200	DIODE 1SS254-TA	1	or	407 007 9904	DIODE 6MA01-BT	1
or	407 007 9904	DIODE 6MA01-BT	1	D929	407 061 2200	DIODE 1SS254-TA	1
D929	407 061 2200	DIODE 1SS254-TA	1	or	407 007 9904	DIODE 6MA01-BT	1
or	407 007 9904	DIODE 6MA01-BT	1	D930	407 061 2200	DIODE 1SS254-TA	1
D930	407 061 2200	DIODE 1SS254-TA	1	or	407 007 9904	DIODE 6MA01-BT	1
or	407 007 9904	DIODE 6MA01-BT	1				

P.C. BOARD PARTS LIST (Continued)

LED P.C. BOARD (BOTTOM VIEW)

Ref. No.	Part No.	Description	Q'ty
LED P.C.B. ASSY			
51	141-0-1939-19830	LED P.C.B. Assy	1
D502	4-2029-75040	LED, SLR 34 VC	1
R501	401 025 3807	CARBON 180 JA 1/6W	1
R502	401 026 4605	CARBON 33K JA 1/6W	1
R503	401 025 3807	CARBON 180 JA 1/6W	1

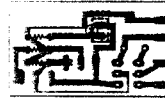

PHOTO TRANSISTOR P.C.B. ASSY			
52	141-0-1939-19840	Photo Transistor P.C.B. Assy	1
D501	4-2039-73120	Photo Transistor, TPS606	1

PHOTO SENSOR P.C.B. ASSY			
53	141-0-1939-19850	Photo Sensor P.C.B. Assy	1
D501	4-2039-73130	Photo Interrupter	1

NOTES:

- Parts order must contain Model Number, Part Number and Description.
- Ordering quantity of screws and resistors must be multiple of 10 pcs.

POWER P.C. BOARD (BOTTOM VIEW)



LAMP P.C. BOARD (BOTTOM VIEW)

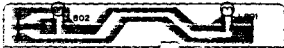

MAIN P.C. BOARD (BOTTOM VIEW)

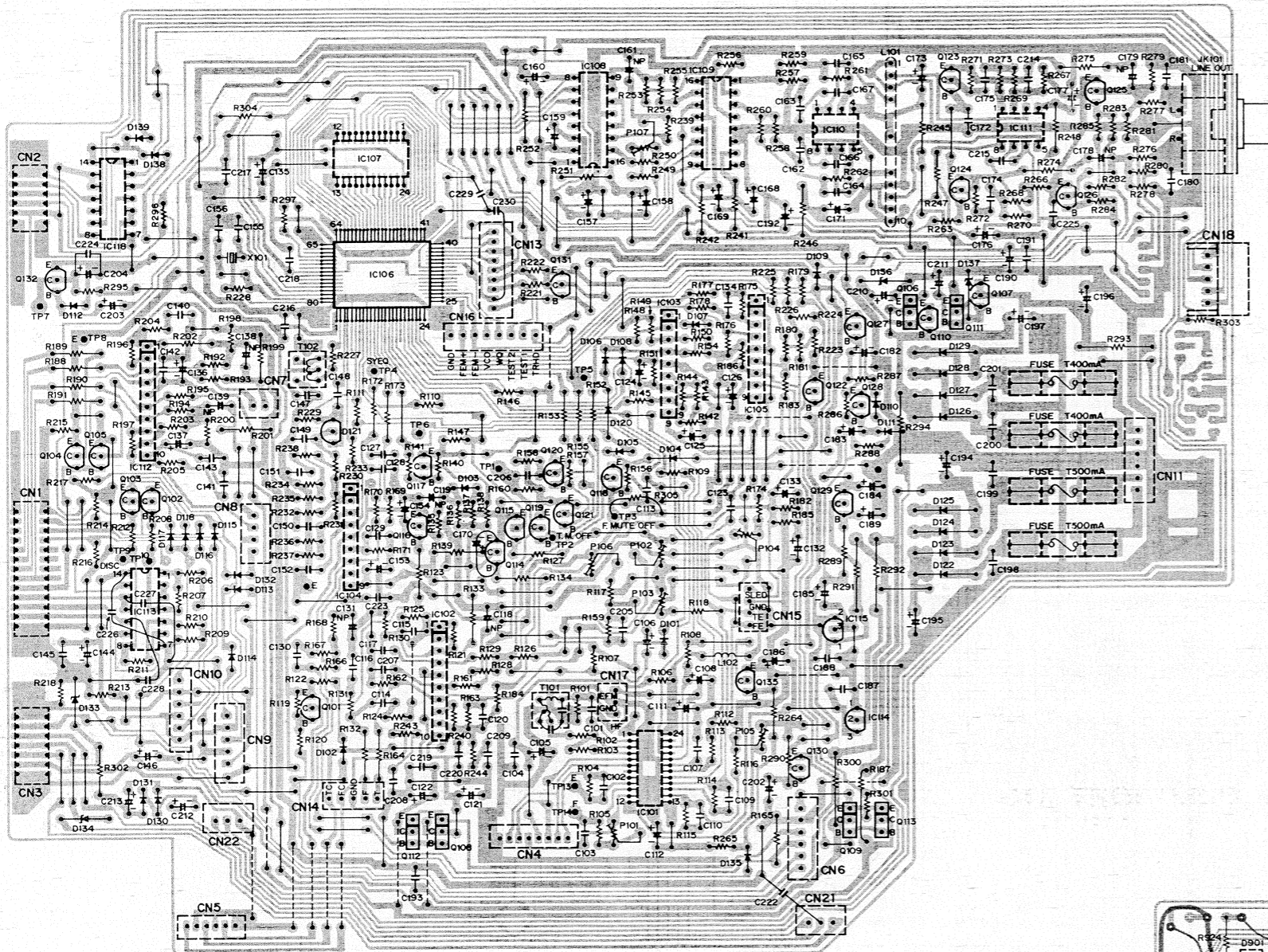

SYMBOL No.	DEVICE	IC PIN NUMBERS DC VOLTAGES																				
		1	2	3	4	5	6	7	8	9	10	11	12	13	14	15	16	17	18	19	20	
IC101	CX20109	-5.6V	0V	0V	0V	0V	0V	0V	0V	0V	0V	0V	0V	0V	0V	0V	0V	0V	0V	0.4V	-3.0V	0V
		21	22	23	24																	
IC102	LA6510	0V	0V	0V	0V	-14.4V	0V	0V	0V	0V	13.9V											
IC103	LA6393S	5.9V	-5.9V	1.6V	0V	-6.0V	0V	0V	5.1V	5.9V												
IC104	μPC4570HA	5.9V	2.6V	2.6V	2.6V	-6.0V	0V	0V	0.2V	5.9V												
IC105	μPC4570HA	5.9V	0V	0V	0V	-6.0V	0V	0V	0.5V	5.9V												
IC107	LC3517	2.5V	2.6V	2.5V	2.5V	2.5V	2.5V	2.5V	2.5V	4.3V	1.3V	3.9V	0V	4.5V	4.1V	1.1V	-	-	0V	-	3.0V	
		21	22	23	24																	
IC108	PCM56P	-8.7V	0V	6.4V	0V	2.1V	3.4V	0V	-7.7V	0V	0V	0V	0V	0V	-6.3V	-1.3V	8.7V					
IC109	TC4053BP	0V	0V	0V	0V	0V	0V	-8.6V	0V	1.7V	1.7V	0V	-8.6V	8.6V	-8.6V	0V	8.6V					
IC110	μPC4570C	0V	0V	0V	-7.3V	0V	0V	0V	7.3V													
IC111	μPC4570C	0V	0V	0V	-8.2V	0V	0V	0V	8.1V													
IC112	LA6510	0V	0V	0V	0V	-14.5V	0V	0V	0V	0V	13.9V											
IC113	μP074CJ04C	5.2V	0V	0V	5.2V	5.1V	0V	0V	5.2V	0V	2.3V	2.6V	2.7V	2.2V	5.2V							

TRANSISTOR DC VOLTAGES				
SYMBOL No.	DEVICE	B	C	E
Q106	2SD1227	9.3V	12.6V	8.7V
Q111	2SB911	-9.3V	-12.6V	-8.7V

SYMBOL No.	DEVICE	IC PIN NUMBERS DC VOLTAGES																				
		1	2	3	4	5	6	7	8	9	10	11	12	13	14	15	16	17	18	19	20	
IC106	YM3815	5.2V	2.3V	2.3V	2.6V	0V	5.2V	0V	4.4V	0V	0V	0V	0V	0V	5.2V	0V	0.3V	5.2V	5.2V	0V	5.2V	
		21	22	23	24	25	26	27	28	29	30	31	32	33	34	35	36	37	38	39	40	
		0V	0V	0V	5.2V	0V	0V	1.9V	1.3V	0.2V	0V	0.2V	5.2V	5.1V	1.7V	0V	0V	0V	0V	5.3V	2.5V	
		41	42	43	44	45	46	47	48	49	50	51	52	53	54	55	56	57	58	59	60	
		0V	2.6V	2.5V	2.5V	2.6V	2.6V	2.6V	2.5V	2.6V	2.9V	4.8V	2.9V									
		61	62	63	64	65	66	67	68	69	70	71	72	73	74	75	76	77	78	79	80	
		4.3V	0V	3.4V	0V	0V	0V	2.5V	2.0V	5.2V	5.1V	0V	5.2V	3.5V	0V	5.1V	1.7V	1.1V	0V	2.3V	1.8V	

CONTROL P.C. BOARD (BOTTOM VIEW)

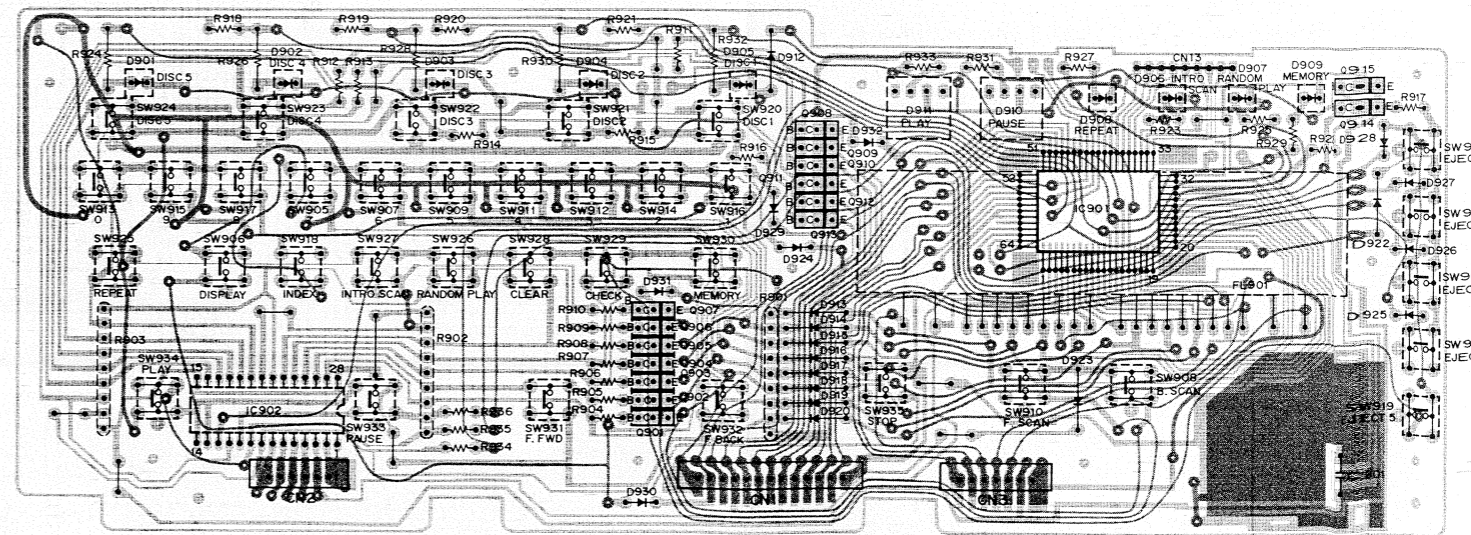

SCHEMATIC DIAGRAM

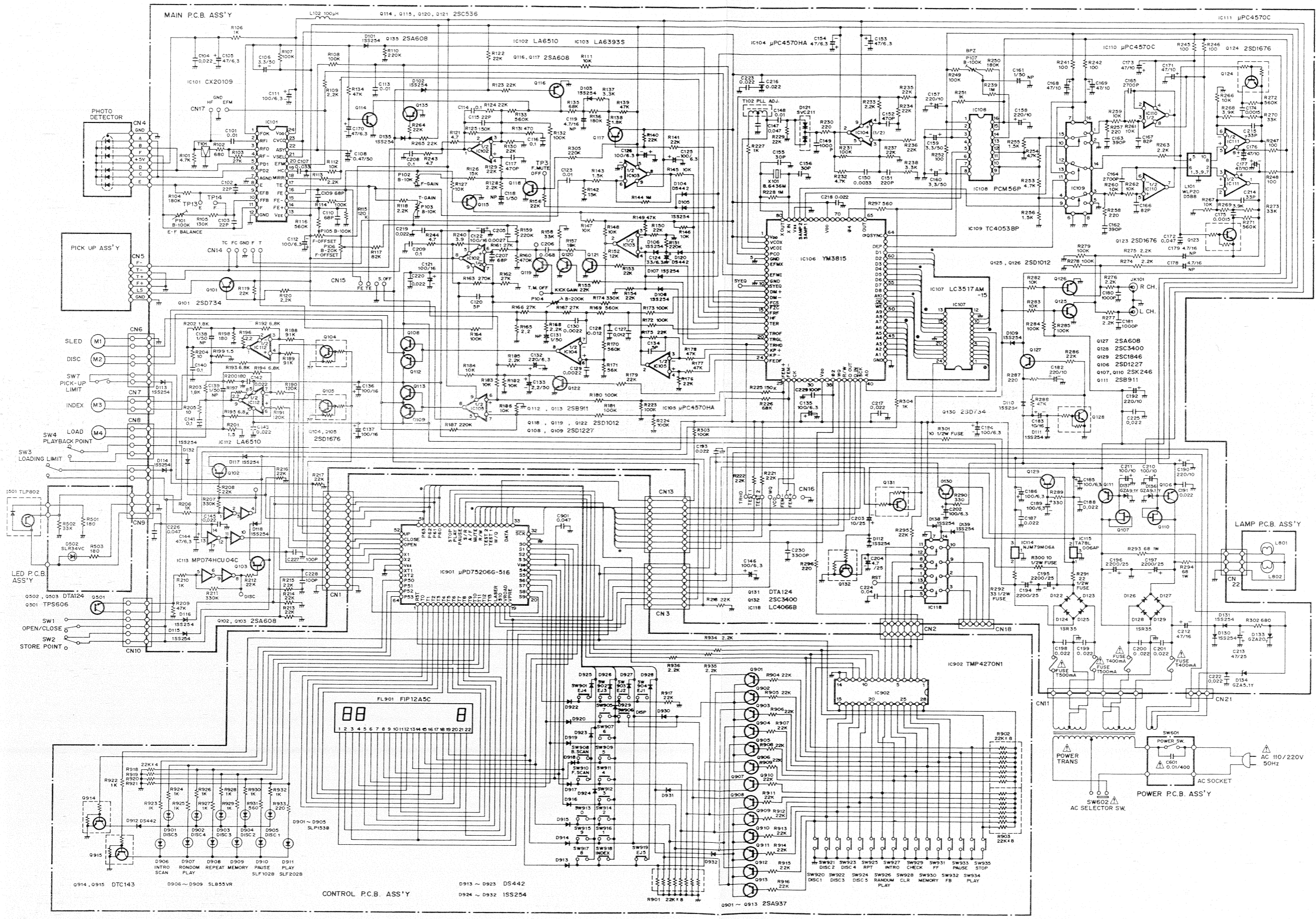

POINT TO POINT WIRING DIAGRAM

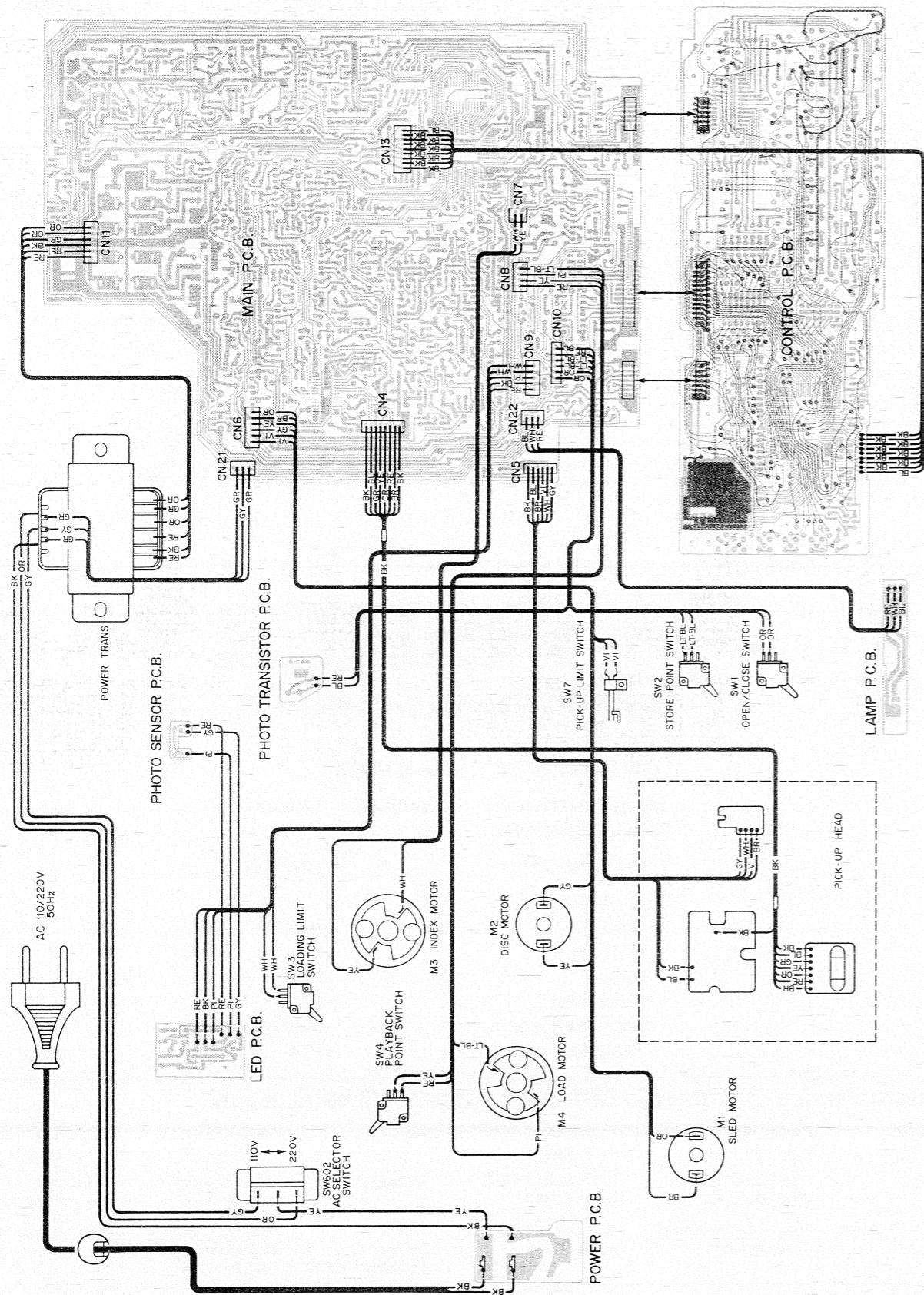

INTEGRATED CIRCUIT BLOCK DIAGRAM

YM3815 BLOCK DIAGRAM

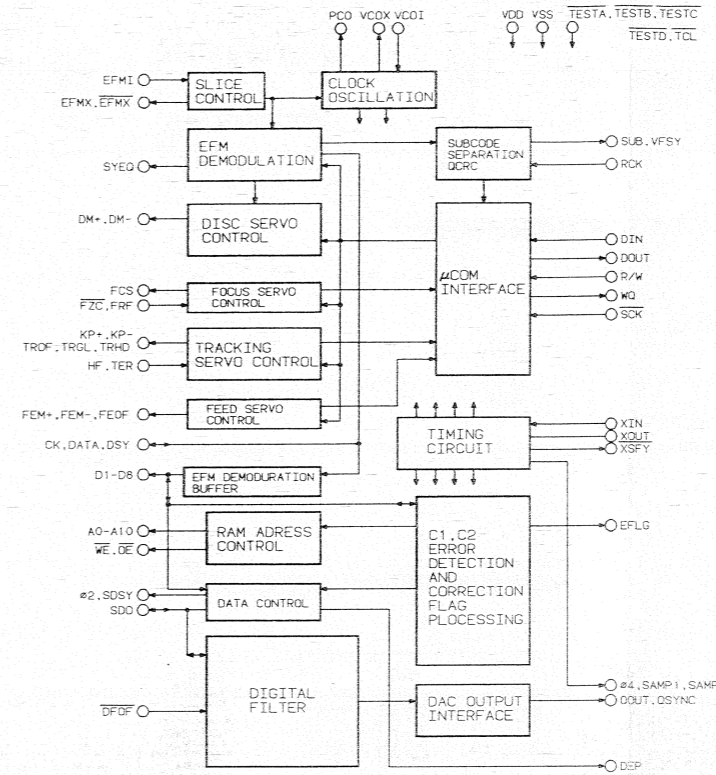

μPC4570HA/LA6393S BLOCK DIAGRAM

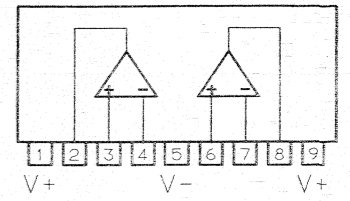

LC3517AM-15 BLOCK DIAGRAM

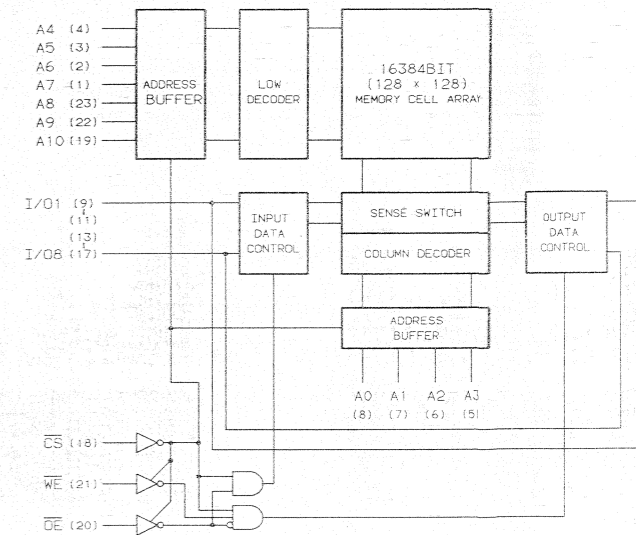

CX20109 BLOCK DIAGRAM

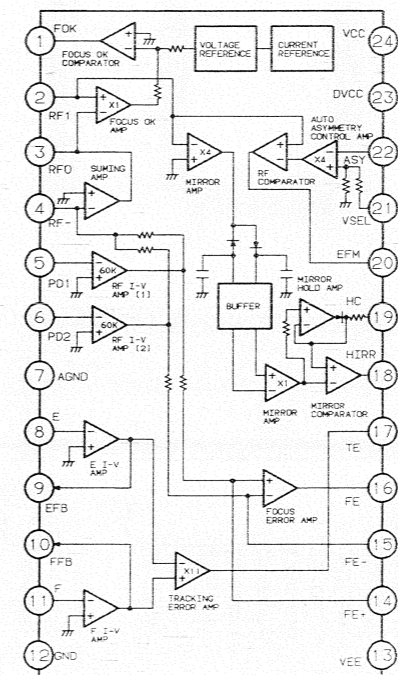

LA6510 BLOCK DIAGRAM

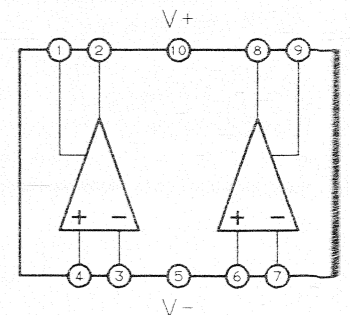

SEMICONDUCTOR LEAD IDENTIFICATION

μPC4570C BLOCK DIAGRAM

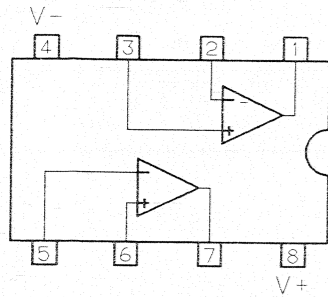

μPC4570HA TOP/SIDE VIEWS

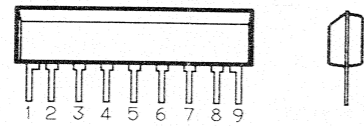

CX20109 TOP/SIDE VIEWS

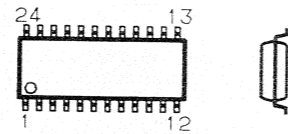

LC3517AM-15 TOP/SIDE VIEWS

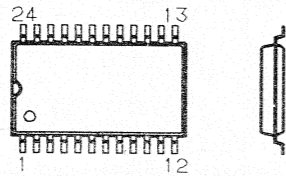

TRANSISTOR	FRONT VIEW	BOTTOM VIEW
2SA608 2SC536 2SD734		
	E C B	E C B
2SC3400 2SD1012		
	E C B	E C B
DTA124 DTC143		
	E C B	E C B
TERMINAL NAME		
B → BASE C → COLLECTOR E → EMITTER		

LA6393S FRONT/SIDE VIEWS

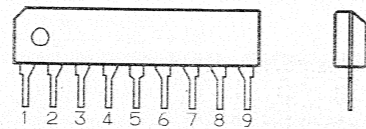

YM3815 TOP/SIDE VIEWS

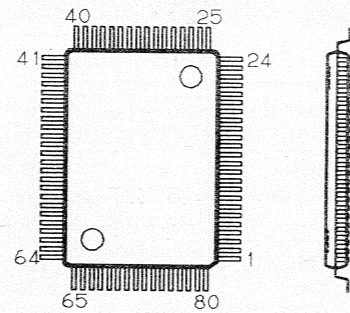

LA6510 FRONT/SIDE VIEWS

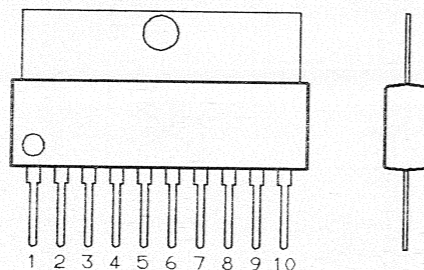

FISHER Hi-Fi Europa Vertriebs GmbH

Stahlgruberring 4 Tel: 089/420 45-0
8000 München 82 Tlx: 524033

Technisches Labor/ Durchwahl -120/121
Qualitätskontrolle

Funkstörmeßlabor -127/128

Service-Zentrale
Color TV -166
Hi-Fi/Audio -168
Video -172
Autoradio -170
Ersatzteillager -155/156
Techn. Schulung -174

Weitere Service-Zentralen in BRD (keine Ersatzteilbestellungen)

Offenbach/ Frankfurt	Frankfurter Straße 121 6050 Offenbach	Tel: 069/88 80 45/48 Tlx: 4 12 558	Hamburg	Spaldingstraße 1 2000 Hamburg	Tel: 040/23 12 23/24 Tlx: 2 173 839
Military	Frankfurter Straße 121 6050 Offenbach	Tel: 069/88 80 45/48 Tlx: 4 12 558	Ditzingen	Max-Eyth-Straße 11 7257 Ditzingen	Tel: 07156/50 88 Tlx: 7 245 278
Düsseldorf-Erkrath	Albert-Einstein-Straße 8 4006 Erkrath 1	Tel: 0211/200 05-0 Tlx: 8 588 563	Berlin (Fisher Vertragswerkstatt)	Drewitz & Kaulbach Eisenacher Straße 53 1000 Berlin 62	Tel: 030/781 20 01 Tlx: 186 460

Unser FISHER-Team steht Ihnen jederzeit gerne zur Verfügung. Ersatzteilbestellungen wickeln Sie bitte ausschließlich mit unserer Service-Zentrale München ab.

Senden Sie uns im Garantiefall die ausgefüllte Garantiekarte ein. Bei unverkauften Lagergeräten des Fachhandels gilt als Garantienachweis eine eidesstattliche Versicherung mit eingetragener Modellbezeichnung und Geräte-Nummer oder ein Liefernachweis. Die gleiche Regelung besteht auch für Reparaturaufträge.

Bitte geben Sie unbedingt die Ersatzteil-Nummer und die Modellbezeichnung an.
Sie sparen so wertvolle Zeit. Vielen Dank.